



J&S HOUSEHOLD PRODUCTS CO.,LIMITED



A company specializing in cabinet design, R&D, production

About us

JS HOUSEHOLD started development in 2003 and has now developed into one of the leading kitchen manufacturers in Guangdong Province. Covering an area of about 10,000 square meters, the monthly output can reach 40,000 square meters of panels and about 25,000 sets of standard cabinets.

Over the years, the company aims to further expand its production capacity through funds, enhance its global brand awareness and Enhance its informationization level. JS's passion for perfection and its passion for personalized kitchens and lifestyles continue to drive.

For many years, JS has been working tirelessly to expand our international market.

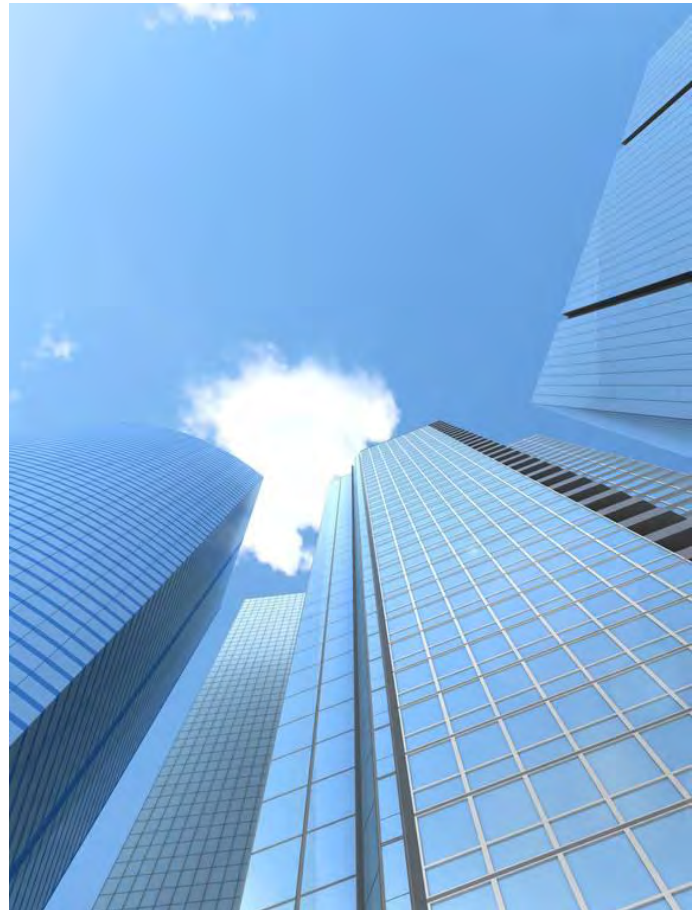

JS has the world's leading HOMAG woodworking production line. JS's production lines and processes are the leading equipment and technology of the era. JS uses E1 or CARB-compliant panels as raw materials. In addition, we also purchased other necessary raw materials from leading Chinese brands, such as particleboard, MDF, and edge banding. If you want more details, please contact us and we will contact you within 2 working days.

Contents



Kitchen

Page 01



Door profile

Page 12



Hardware

Page 16



Flat Pack Cabinet

Page 17



Wardrobe

Page 25

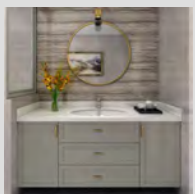

Vanity

Page 34

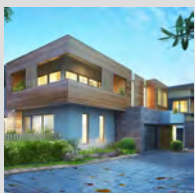

Project Case

Page 35

Melamine



黑胡桃

M-03



意大利白

L-11M

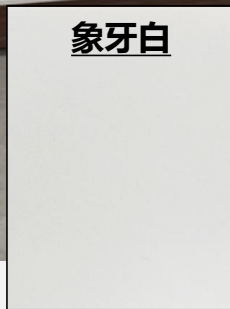

象牙白

SL1013



✓ Melamine is rich-colored and it is the public preferences material .The island's double-sided cabinets shows spacious and capacious, add some decorative accessories, adding brighting to the entire kitchen. Black walnut with white base cabinet this matches is more suitable for elderly owners



M-11

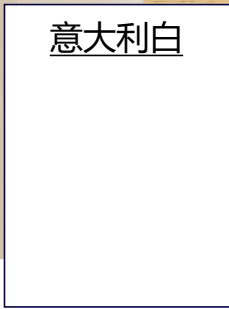

L-11M

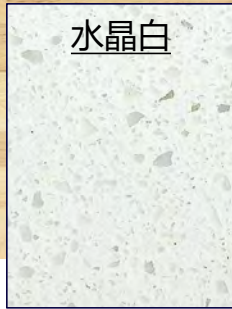

SL3012



✓ This is a I shape 3 meters affordable kitchen cabinet. Base unit with yellow melamine , wall unit in white melamine door. Very simple design but good practicability. With popular white quartz stone, melamine maple wood color. This is a design based on the factor of economic and practical.

Melamine



M-12

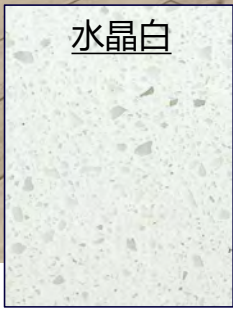

SL3012



✓ Simple L shape design ,melamine door it because the double-sided expansion coefficient of the plate is not easy to be deformed, the color is bright, the surface is more wear-resistant, corrosion-resistant, and the price is economical.



柠檬黄

意大利白

水晶白



L-14B

L-11B

SL3012

✓ The white glossy white lacquer is mainly color in this design, with the open shelves of individual lemon yellow, gives the kitchen with warm and elegant atmospheret. It is a typical nordic style for young people.

KITCHEN

Lacquer



J&S HOUSEHOLD PRODUCTS CO.,LIMITED

子午灰

水晶白

L-23B

SL3012

✓ This is also a set of I-type small kitchen cabinet design. High-grade gray is a contemporary popular color. The lacquer is made of premium paint, combined with PU and PE high is stain-resistant and durable, resistant to scratches, acids and alkalis, heat, and pollution.

KITCHEN

Lacquer

J&S HOUSEHOLD PRODUCTS CO.,LIMITED

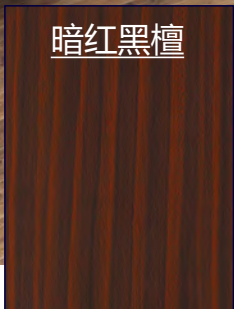

暗红黑檀

L-44B



意大利白

L-11B



鱼肚白

SL-CC102

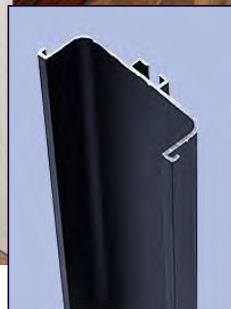

✓ The wooden veneer glossy lacquer door kitchen cabinet is characterized by bright color and easy shape, strong visual impact, very beautiful and fashionable, excellent waterproof performance, strong anti-pollution ability and easy to clean.

Black U channel aluminum alloy embedded handle on base unit,touch open door for wall unit,Tandem box marble looking countertop.

KITCHEN

Lacquer

J&S HOUSEHOLD PRODUCTS CO.,LIMITED



绅士灰

Golden
Years Oak

鱼肚白

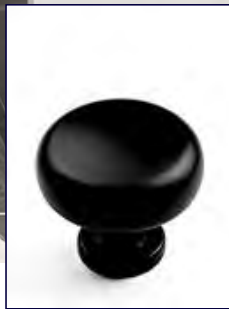

L-21M

M-10

SL-CC102

✓ Shaker style is most popular all over the world. Shaker door kitchen cabinet usually made by painting or PVC or Melamine. It is popular and modern design, suitable for European style house.

Good quality PVC kitchen cabinet door substrate is not easy to be deformed, and has good environmental protection performance, fine appearance, abrasion resistance, scratch resistance, high temperature resistance and flame retardant performance.

Thermoformed

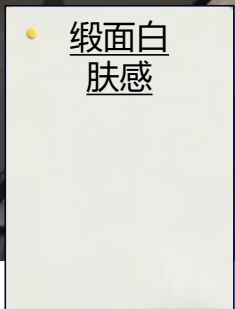

JP623H



M-14



SL3004



✓ Skin sensitive finished is the new material recent year. This design based on luxury style kitchen cabinet with cabinet LED lights strip, shelf lights, kickboard lights, make the kitchen room more warm and dazzling. Pantries with slide out shelves, The aluminum black moulding match the white thermoformed which is a fashion matches.

Thermoformed

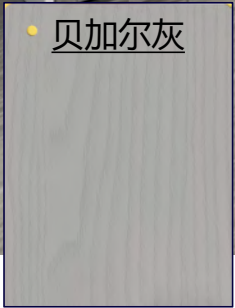
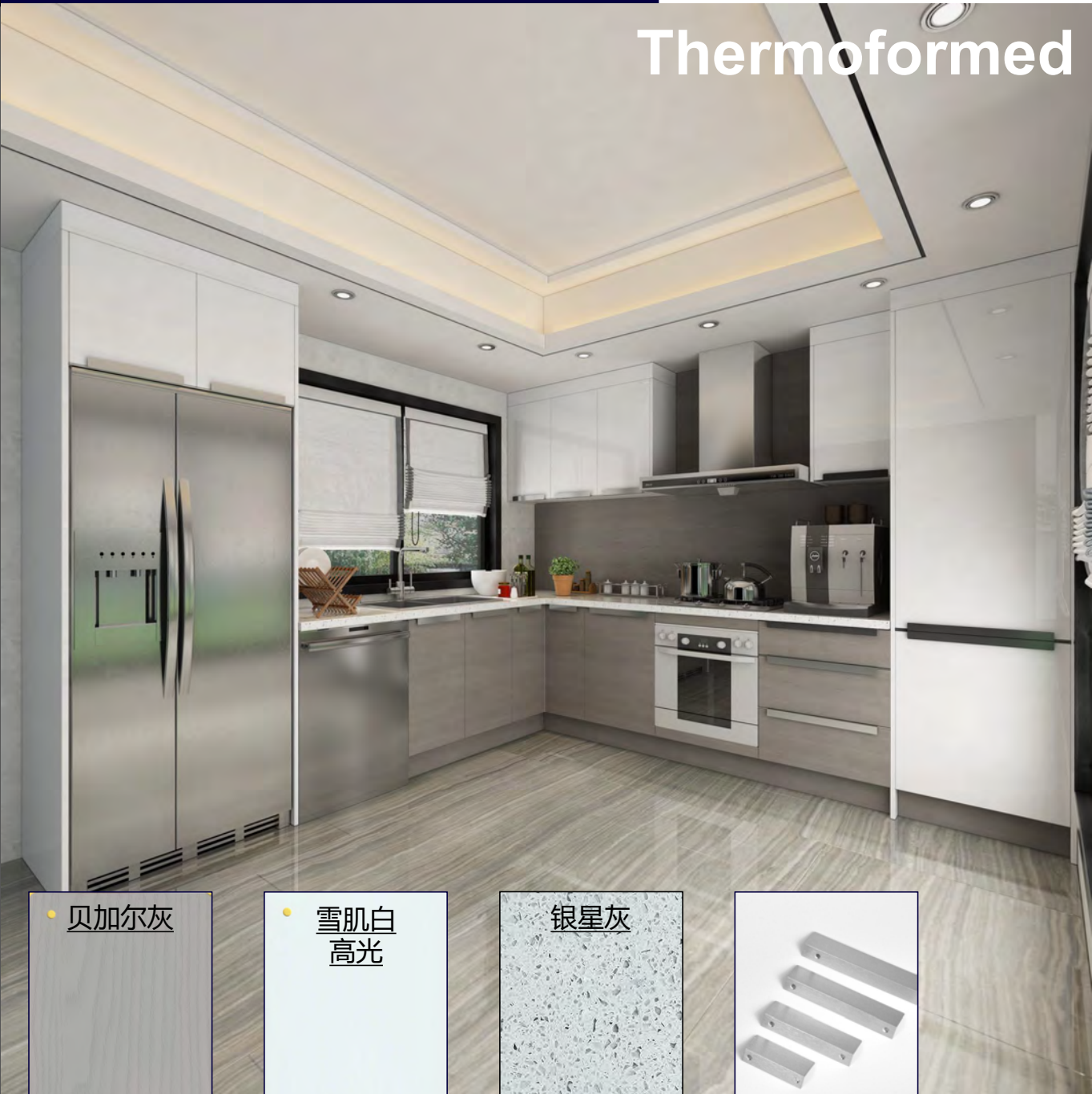

• 贝加尔灰

JP628H

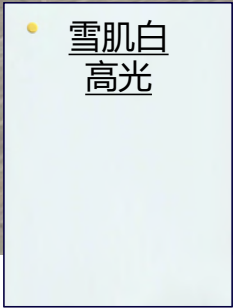

• 雪肌白
高光

JP702H

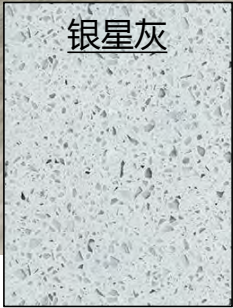

银星灰

SL3009

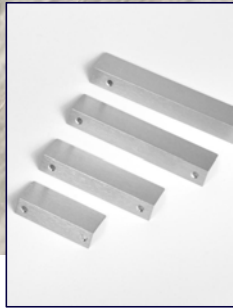

✓ Thermoformed door panels colourful options, realistic wood grain, pure monochrome chroma, no cracking and deformation, scratch resistance, heat resistance, stain resistance, and fade resistance. It is the most mature cabinet material, and daily maintenance is simple.

KITCHEN

Thermoformed



J&S HOUSEHOLD PRODUCTS CO., LIMITED



瓷白
哑光

JP641H



流金岁月

M-10

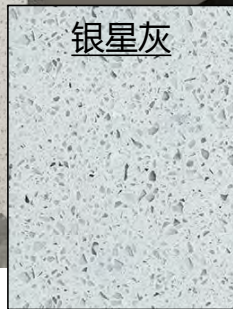

银星灰

SL3009

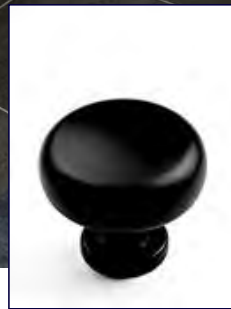

✓ Premium PVC shaker kitchen cabinet door is not easy to be deformed, and has good environmental protection performance, fine appearance, abrasion resistance, scratch resistance, high temperature resistance and flame retardant performance. White shaker door perfectly match with Black knob or Pucket handle.

Thermoformed



• 罗马黑

JP636H



金玉满堂

SL4007



✓ Wood veneer door panel composite MDF with solid veneer or tech veneer, Generally, the surface of the solid wood is bumped and painted in the production to maintain the original wood color and beautiful shape. Open painting to guarantee the texture of the solid wood, and the closed painting will make the surface smoother. This can ensure the special visual effect of solid wood, and the combination of the frame and the core board can also ensure the strength of the door panel.

Door Profile



J&S HOUSEHOLD PRODUCTS CO., LIMITED



Cabinet connection

Type one

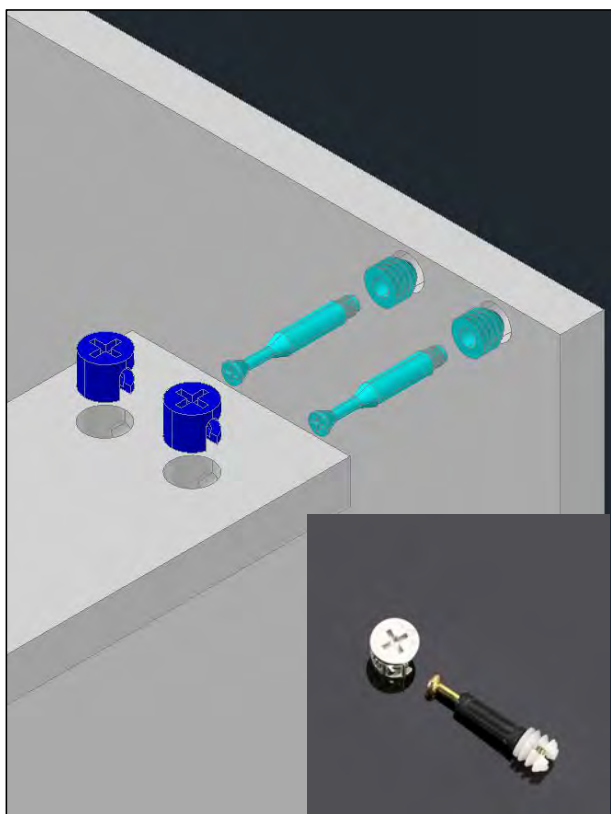

CAM LOCK

Type Two

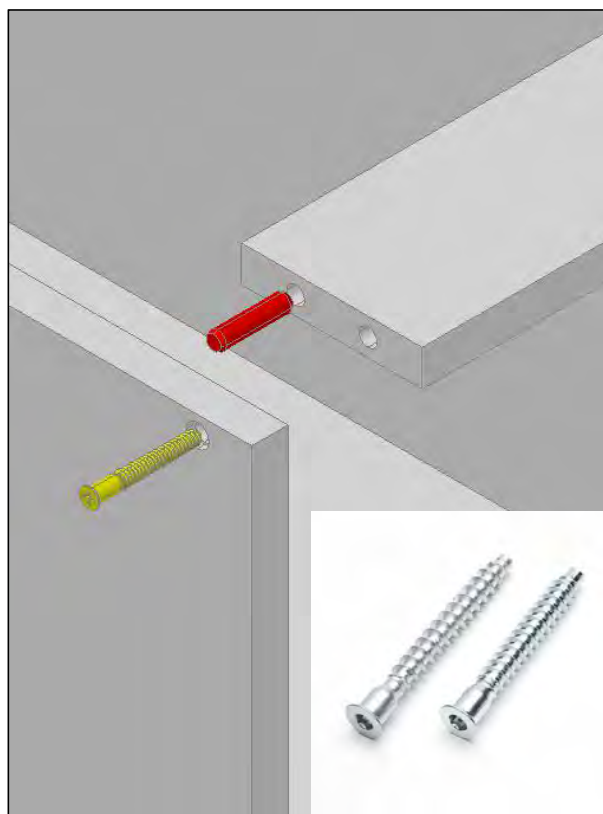

SCREWS

Adjustable leg

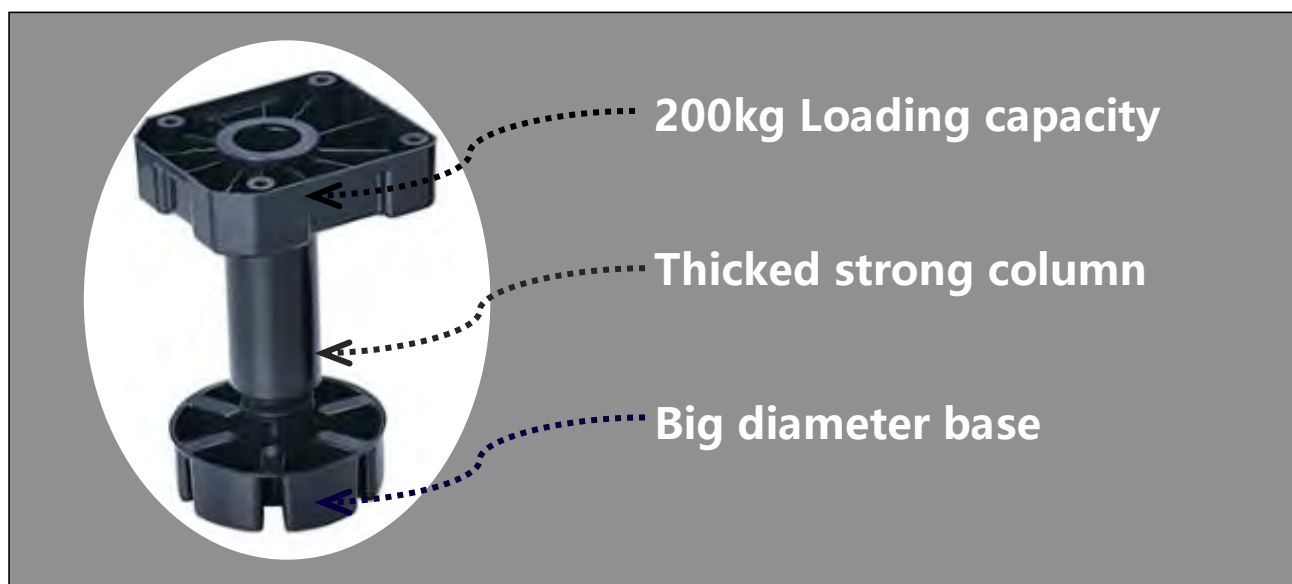

Door Hinge



Blum clip top hinge

- ☆ Austrian brand
- ☆ 500,000 times opening&closing
- ☆ 3D adjustment
- ☆ Toolless installation and removal
- ☆ Combined with blumotion damping



DTC

- ☆ Hydraulic integrated damping
- ☆ China top brand
- ☆ 200,000 times opening&closing
- ☆ Clip top easy installation and removal
- ☆ Economic applicability

Drawer Rail

Under-Mounted drawer rail



SS10 Series

- Load capacity:35kg
- Finish:Zink Plated
- Length:250-600mm
- Full extension
- Tool free assembly &removal
- Silent system guarantees smooth runner
- ±3mm up&down adjustment

Tandem Box



MiniBOX Series

- Load capacity:40kg
- Finish:Zink Plated
- Length:270-550mm
- Full extension
- Ultra-thin drawer sides
- Premium grey Metal side,frosted glass sides
- Widely use in kitchen storage system

Kitchen Accessories



Pull out Rack
200 Cabinet



Pull out basket
300/400 Cabinet



Magic pull basket
900 Blind corner Cabinet



Magic pull basket
900 Blind corner Cabinet



Turn table
1000 Blind corner Cabinet



180° Corner basket
900 Blind corner Cabinet

悍高 HIGOLD

NUOMI 诺米

WELL
MAX

Kitchen Accessories



270°Corner basket
900 Corner Cabinet



Plate basket
800/900 Cabinet



Plate basket
800/900 Cabinet



Pantry roll-out basket
600 Pantry



Pantry pull out basket
400 Pantry



Revolving tall unit
400 Pantry

悍高 HIGOLD

NUOMI 诺米

WELL
MAX

Flat Pack Cabinet



• Base Unit



• Wall unit



• Pantry unit

Flat Pack Cabinet

Base Units

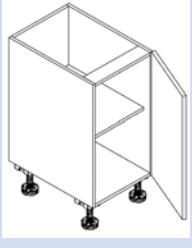
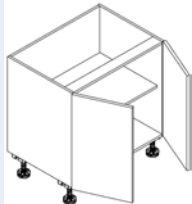

Open Door Base

Picture	Description	Code	W	D	H	Code
	Base unit, one door	BXX72	200	580	720	B2072
			300	580	720	B3072
			400	580	720	B4072
			450	580	720	B4572
			500	580	720	B5072
	Base unit, two doors	BXX72	600	580	720	B6072
			700	580	720	B7072
			800	580	720	B8072
			900	580	720	B9072

Sink Base

Picture	Description	Code	W	D	H	Code
	Base sink unit, two doors	BSXX72	600	580	720	BS6072
			700	580	720	BS7072
			800	580	720	BS8072
			900	580	720	BS9072

Oven Base

Picture	Description	Code	W	D	H	Code
	Base oven unit	BOVXX72	600	580	720	BOV6072
			900	580	720	BOV9072
	Base oven unit	BOVXX72-B	600	580	720	BOV6072-B
			900	580	720	BOV9072-B

Flat Pack Cabinet

Base Units

Drawer Base

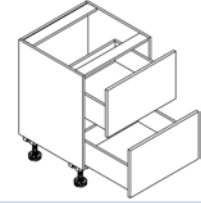
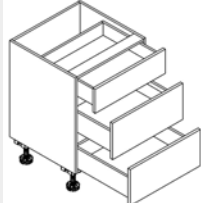
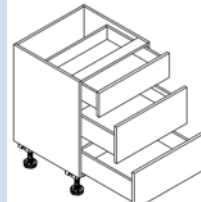
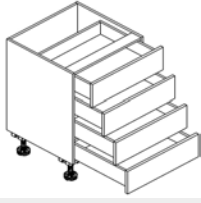
Picture	Description	Code	W	D	H	Code
	Base two drawer unit	B2DXX72	400	580	720	B2D4072
			450	580	720	B2D4572
			600	580	720	B2D6072
			750	580	720	B2D7572
			800	580	720	B2D8072
			900	580	720	B2D9072
	Base three drawer unit(Equal divide)	B3DXX72	450	580	720	B3D4572
			600	580	720	B3D6072
			750	580	720	B3D7572
			800	580	720	B3D8072
			900	580	720	B3D9072
	Base three drawer unit(one small two deep)	B3DXX72-B	450	580	720	B3D4572-B
			600	580	720	B3D6072-B
			750	580	720	B3D7572-B
			800	580	720	B3D8072-B
			900	580	720	B3D9072-B
	Base four drawer unit	B4DXX72	450	580	720	B4D4572
			600	580	720	B4D6072
			750	580	720	B4D7572
			800	580	720	B4D8072
			900	580	720	B4D9072

Microwave oven Base

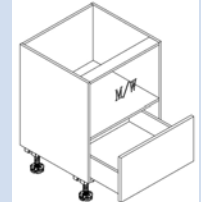
Picture	Description	Code	W	D	H	Code
	Base Microwave oven unit	BMXX72	600	580	720	BM6072

Flat Pack Cabinet

Base Units

Functional Base

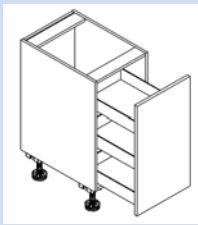
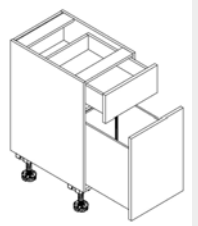
Picture	Description	Code	W	D	H	Code
	Base pull out basket unit	BBXX72	300	580	720	BB3072
			400	580	720	BB4072
	Base pull out bin unit	BTXX72	300	580	720	BT3072
			400	580	720	BT4072

Corner Base

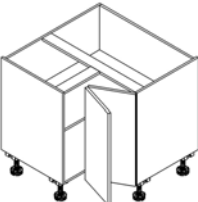
Picture	Description	Code	W	D	H	Code
	Base Blind corner unit	BCXX72-L/R	900	580	720	BC9072-L
			900	580	720	BC9072-R
	Base corner unit	BCCXX72	900	900	720	BCC9072

Wine Rack Base

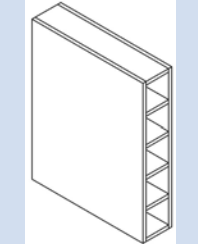
Picture	Description	Code	W	D	H	Code
	Wine rack	WRXX72	150	580	720	WR1572

Flat Pack Cabinet

Wall Units

Open Door Wall

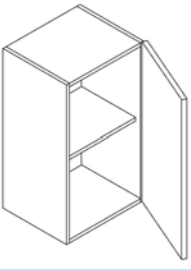
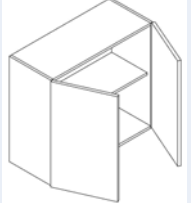
Picture	Description	Code	W	D	H	Code
	Wall unit, one door	WXX72	300	350	720	W3072
			350	350	720	W3572
			400	350	720	W4072
			450	350	720	W4572
			500	350	720	W5072
	Wall unit, two doors	WXX72	600	350	720	W6072
			700	350	720	W7072
			800	350	720	W8072
			900	350	720	W9072

Flat Up Wall

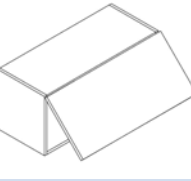
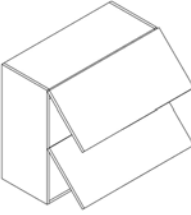
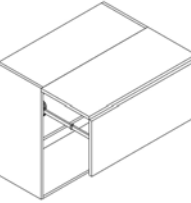
Picture	Description	Code	W	D	H	Code
	Wall flap up unit, one door	WFXX36	600	350	720	WF6036
			700	350	720	WF7036
			800	350	720	WF8036
			900	350	720	WF9036
	Wall flap up unit, two doors	WFXX72	600	350	720	WF6072
			700	350	720	WF7072
			800	350	720	WF8072
			900	350	720	WF9072
	Wall flap up unit, bi-fold door	WFXX72-HF	600	350	720	WF6072-HF
			700	350	720	WF7072-HF
			800	350	720	WF8072-HF
			900	350	720	WF9072-HF

Flat Pack Cabinet

Wall Units

Microwave Oven Wall

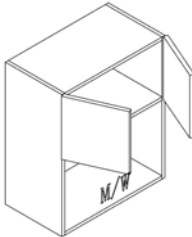
Picture	Description	Code	W	D	H	Code
	Wall Microwave oven unit	WMXX72	600	350	720	WM6072

Corner Wall

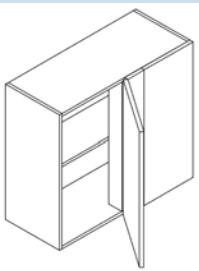
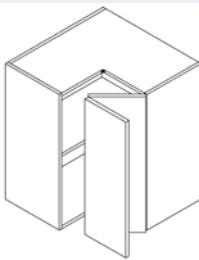
Picture	Description	Code	W	D	H	Code
	Wall Blind corner unit	CWXX72-L/R	600	350	720	CW6072-L/R
	Wall corner unit	CCWXX72	600	600	720	CCW6072



Wall Open Door Unit



Wall Flat Up Unit



Wall Corner Unit

Flat Pack Cabinet

Pantry Units

Open Door Pantry

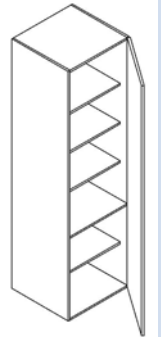
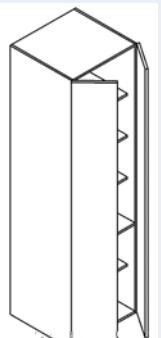
Picture	Description	Code	W	D	H	Code
	Tall unit with one door	TXX21	300	580	2150	T3021
			400	580	2150	T4021
			450	580	2150	T4521
			500	580	2150	T5021
			600	580	2150	T6021
	Tall unit with two doors	TXX21	600	580	2150	T6021
			700	580	2150	T7021
			750	580	2150	T7521
			800	580	2150	T8021
			900	580	2150	T9021

Drawer Pantry

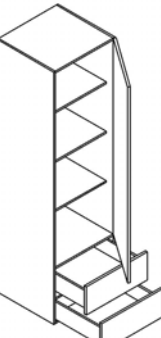
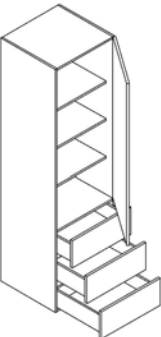
Picture	Description	Code	W	D	H	Code
	Tall unit with two drawers and one door	T2DXX21	450	580	2150	T2D4521
			600	580	2150	T2D60021
	Tall unit with two drawers and two doors		700	580	2150	T2D7021
			750	580	2150	T2D7521
			800	580	2150	T2D8021
	Tall unit with three drawers and one door	T3DXX21	450	580	2150	T3D4521
			600	580	2150	T3D6021
	Tall unit with three drawers and two doors		700	580	2150	T3D7021
			750	580	2150	T3D7521
			800	580	2150	T3D8021

Flat Pack Cabinet

Pantry Units

Functional Pantry

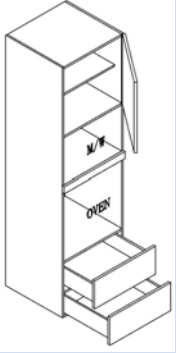
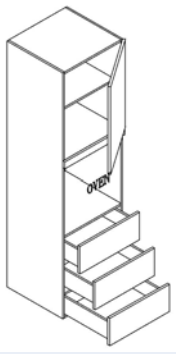
Picture	Description	Code	W	D	H	Code
	Tall unit with two drawers, Oven and microwave	TOMXX21	600	580	2150	TOM6021
	Tall unit with two drawers and Oven	TOXX21	600	580	2150	TO6021

Oven Tower

Picture	Description	Code	Component	W	D	H	Quantity
	Oven Tower two drawers , Oven , microwave and single flap up unit	TOVXX21	End Panel	600	18	2400	2
			Drawer Unit	600	580	290	2
			M/W Box	600	430	520	1
			Flat up unit	600	350	360	1
			Filler	600	18	85	1

Walk-in closet

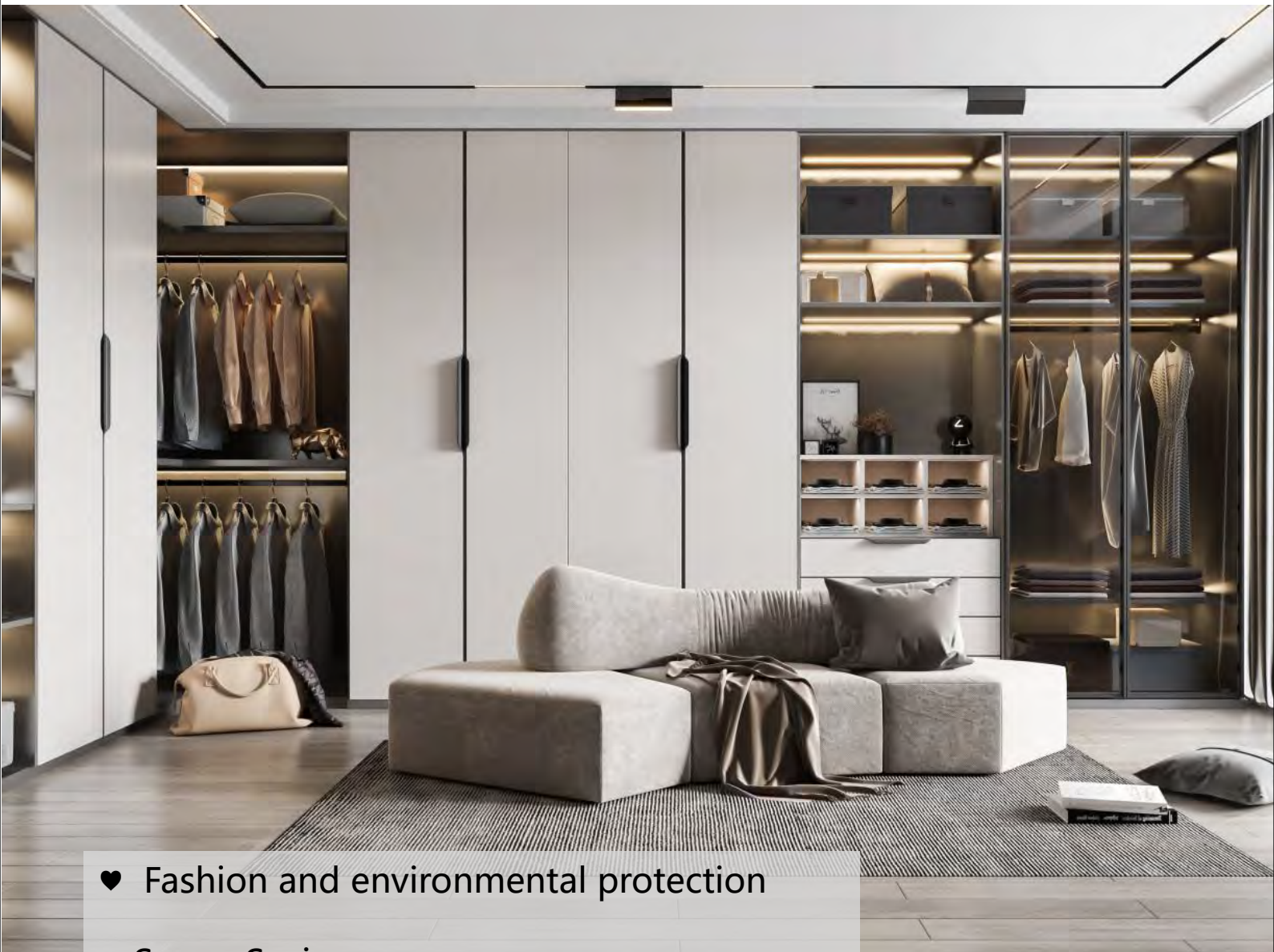

- ♥ Fashion and environmental protection
- ♥ Space-Saving
- ♥ Convenient clothing storage
- ♥ Various functional areas

Walk-in closet



- ♥ Simple wood grain design
- ♥ Larger space capacity
- ♥ Pants rack tie rack storage box
- ♥ Space-saving design

Aluminum pole closet



- ♥ Custom Light luxury series
- ♥ Aluminum pole system
- ♥ Glass door shelter
- ♥ Easy assembling design

Hinged door wardrobe



- ♥ Hinged door for small sizes room
- ♥ Thermoformed door panel
- ♥ European style
- ♥ Freestanding design



Hinged door wardrobe



- ♥ Advanced grey texture melamine
- ♥ Deformation resistance
- ♥ Sliding system
- ♥ Innovative painting door design

Hinged door wardrobe



- ♥ Random combination
- ♥ Full height to ceiling
- ♥ Nordic minimalist style
- ♥ Lacquer/painting hinged door panel



Sliding door wardrobe

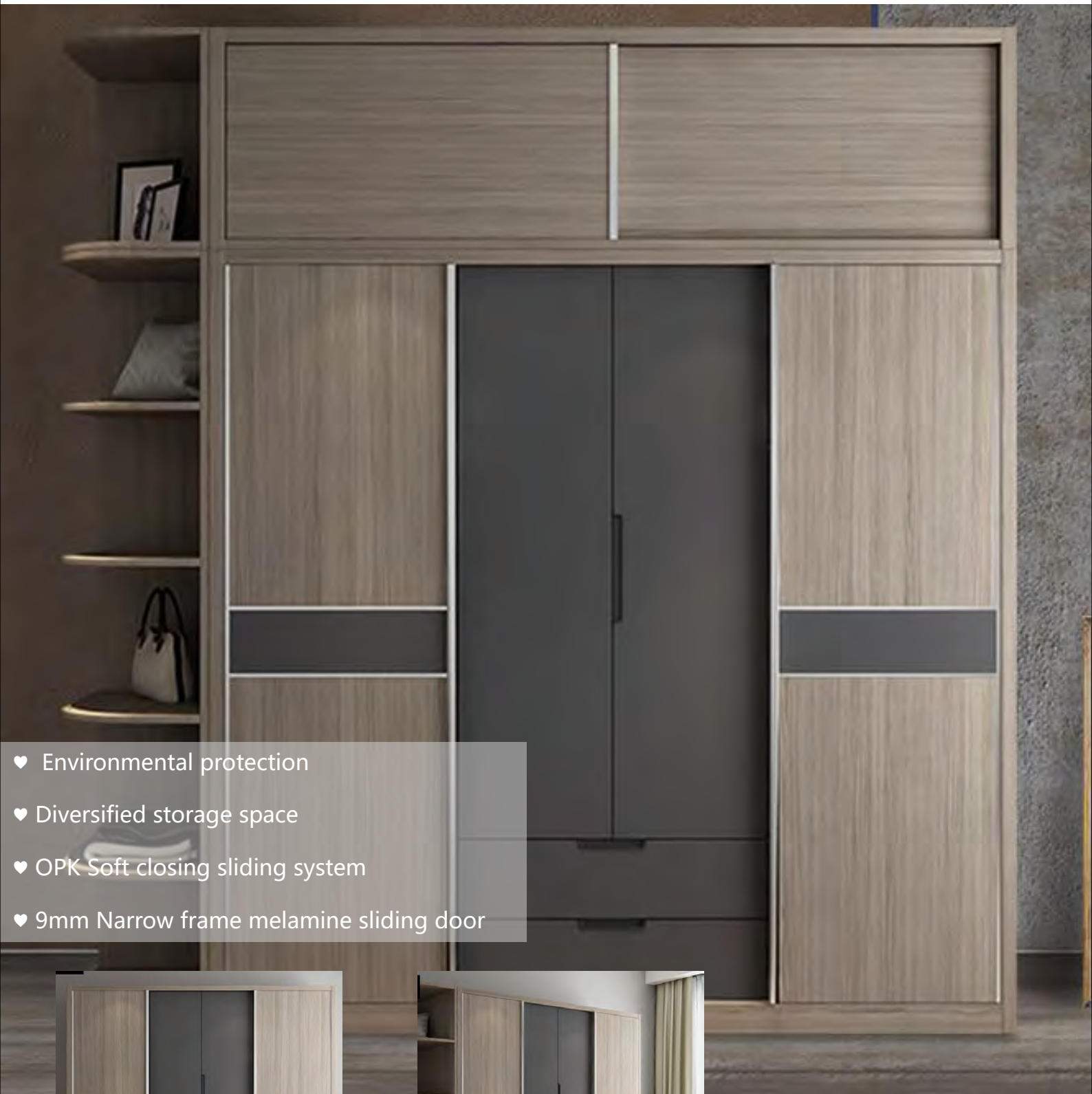

- ♥ Environmental protection
- ♥ Diversified storage space
- ♥ OPK Soft closing sliding system
- ♥ 9mm Narrow frame melamine sliding door



Sliding door wardrobe



- ♥ Large-capacity storage
- ♥ Environmental protection material
- ♥ Soft closing system narrow frame
- ♥ Complete functional area for easy item classification



Sliding door wardrobe



- ♥ Texture finished door material
- ♥ Business style
- ♥ Warm and comfortable
- ♥ Maximize utilization for bedroom



VANITY SERIES



PROJECT CASE



10+
Years Experience

100+
Export Cities

1000+
Global projects

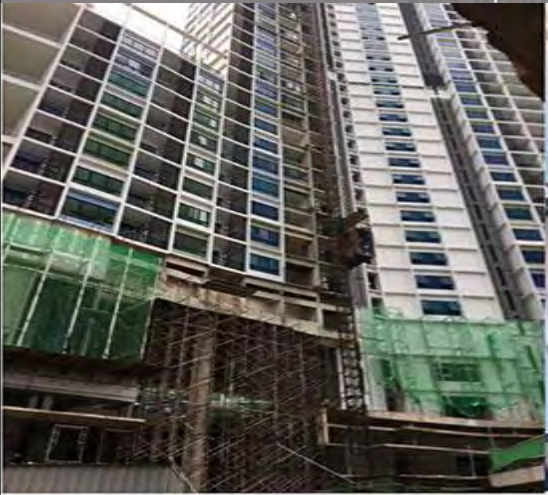

Malaysia
2000 units residential
Kitchen&bathroom&TV cabinet



Panama
2500 units Government low-rent housing
Kitchen&bathroom



PROJECT CASE



New Zealand
132 units Lot House project
Flat Pack Kitchen



Cambodia
150 unit Apartments
Kitchen & wardrobe



Canada
258 unit houses
Kitchen & Bathroom



Australia
72 units villa projects
Kitchen & bathroom



J&S

J&S HOUSEHOLD PRODUCTS CO.,LIMITED



Web:www.jsshome.com
Email :sales@jsshome.com
Phone:+86-13250254997